

It is about Bioclimatica

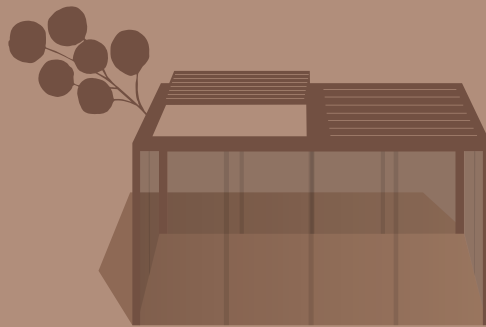

KE

KE

IT La rappresentazione grafica dei prodotti (immagini, dati tecnici e descrizioni) è realizzata al solo scopo di illustrare il prodotto ed è puramente indicativa.

EN The graphic representation of the products (pictures, technical data and descriptions) is made for the sole purpose of illustrating the product and is purely indicative.

FR La représentation graphique des produits (photos, données techniques et descriptions) est faite dans le seul but d'illustrer le produit et est purement indicative.

ES La representación gráfica de los productos (fotografías, datos técnicos y descripciones) se realiza con el único fin de ilustrar el producto y es meramente indicativa.

Gamma Kedry

KE

Bioclimatica 5

p. 10

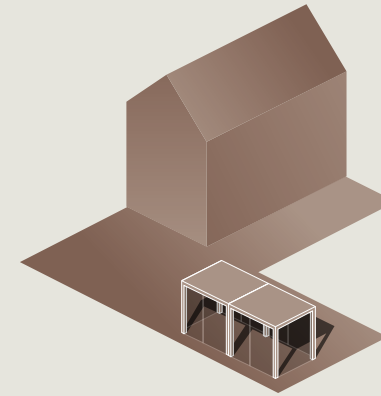

Kedry Skyllife

p. 22

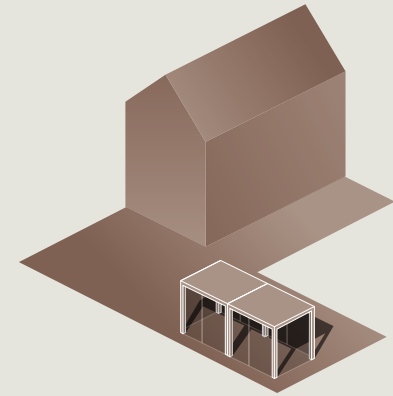

Kedry Prime

p. 32

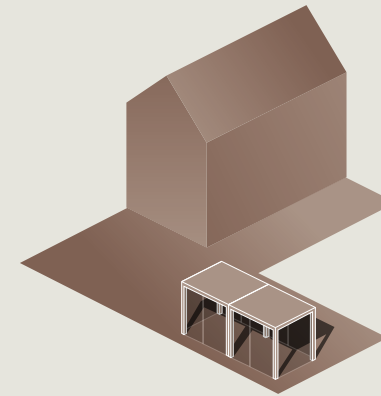

Kedry Plus

KE





la scelta giusta

KE

Bioclimatica 7

KE: THE RIGHT CHOICE
KE, LA CORRECTA ELECCION
KE, LE BON CHOIX.

		
<p>Dal 1987 KE progetta e produce tende a bracci, a cassonetto, a caduta, cappottine, pensiline ed è specializzata in strutture ombreggianti che valorizzano la vivibilità dell'outdoor, fino ad arrivare alla riprogettazione e il restyling dell'arredo urbano. Sia per la varietà di gamma che per la profondità delle configurazioni, KE è una realtà manifatturiera in grado di soddisfare le richieste più esigenti di designer, architetti, serramentisti, tappezzeri e professionisti dell'outdoor.</p> <p>Since 1987, KE designs and manufactures folding arm awnings, cassette, Drop awnings, canopies and it is specialized in shading structures that enhance the livability of the outdoors, up to you get to redesign and restyling of the urban fabric. Both for the variety of the range and for the depth of the configurations, KE is a manufacturing reality in the industry able to fill the most demanding requirements of designers, architects,</p>	<p>fabricators, upholsterers and outdoor professionals.</p> <p>Una realidad de empresa sólida, articulada y de sustancial experiencia, líder en el diseño y la producción de estructuras de protección solar, parte de un grupo, BAT Spa, realidad internacional, que asegura sinergias positivas sobre los materiales, las soluciones y la innovación. KE invierte en investigación para utilizar nuevas soluciones y volver más interesante el impacto estético.</p> <p>Depuis 1987, KE conçoit et fabrique des stores de terrasse, stores verticaux, voiles et pergolas, se spécialisant ainsi dans les structures d'ombrage qui améliorent le confort en extérieur, jusqu'à la refonte du mobilier urbain. Tant par la variété de la gamme que par la profondeur des configurations, KE est une entreprise capable de satisfaire les demandes les plus exigeantes de designers, architectes, fabricants et autres professionnels de l'outdoor.</p>	<p>CICLO DI PRODUZIONE INTERNO automatizzato e all'avanguardia</p> <p>INTERNAL PRODUCTION CYCLE. State of the art and automatized manufacturing process</p> <p>CICLO DE PRODUCCIÓN INTERNO automatizado y a la vanguardia</p> <p>CYCLE DE PRODUCTION INTERNE à la pointe de la technologie et automatisé</p> <p>MASSIMA PERSONALIZZAZIONE DI TUTTI I PRODOTTI tutto il processo di progettazione e ingegnerizzazione del prodotto viene costruito su misura delle esigenze del committente</p> <p>MAXIMUM CUSTOMIZATION FOR ALL PRODUCTS The whole planning and engineering product process is built around customer requirements</p> <p>MÁXIMA PERSONALIZACIÓN DE TODOS LOS PRODUCTOS Todo el proceso de diseño e ingeniería del producto se elabora a medida de las exigencias del comitente</p> <p>PERSONNALISATION OPTIMALE DE TOUS LES PRODUITS L'ensemble du processus de conception et d'ingénierie du produit est adapté aux besoins du client</p>

			
<p>MADE IN ITALY KE è socia di FederlegnoArredo e promuove da sempre la qualità Made in Italy nel mondo</p> <p>MADE IN ITALY KE forms part of FederlegnoArredo, promoting Made in Italy excellence worldwide</p> <p>MADE IN ITALY KE es socia de FederlegnoArredo y promueve desde siempre la calidad Made in Italy en el mundo</p> <p>MADE IN ITALY KE est membre de FederlegnoArredo et a toujours promu la qualité Made in Italy dans le monde entier</p>	<p>INSTALLAZIONE E POST-VENDITA installazione effettuata esclusivamente da personale qualificato KE e assistenza post vendita puntuale e garantita su tutti i prodotti</p> <p>INSTALLATION AND POST-SALE Installation exclusively run by highly trained KE staff and post-sale assistance guaranteed on all products</p> <p>INSTALACIÓN Y POSVENTA Instalación efectuada exclusivamente por personal cualificado KE y asistencia posventa puntual y garantizada en todos los productos</p> <p>INSTALLATION ET APRÈS-VENTE Installation effectuée par des partenaires qualifiés par KE et service après-vente réactif et garanti sur tous les produits</p>	<p>BREVETTI Ricerca e innovazione per performance assolutamente uniche e prodotti inimitabili, grazie a brevetti esclusivi dell'azienda</p> <p>PATENTS Research and innovation for unique performances and products, due to exclusive company patents</p> <p>PATENTES Investigación e innovación para lograr rendimientos absolutamente únicos y productos inimitables, gracias a patentes exclusivas de la empresa</p> <p>BREVETS Recherche et innovation pour des performances absolument uniques et produits inimitables, grâce aux brevets exclusifs de l'entreprise</p>	<p>CERTIFICAZIONI Marcature CE: Uni ISO 9001:2015 Uni ISO 45001: 2018 Uni ISO 14001: 2015 UNI EN 1090:2014</p> <p>CERTIFICATIONS CE: Uni ISO 9001:2015 Uni ISO 45001: 2018 Uni ISO 14001: 2015 UNI EN 1090:2014</p> <p>CERTIFICACIONES Marcados CE: Uni ISO 9001:2015 Uni ISO 45001: 2018 Uni ISO 14001: 2015 UNI EN 1090:2014</p> <p>CERTIFICATIONS Marquages CE: Uni ISO 9001:2015 Uni ISO 45001: 2018 Uni ISO 14001: 2015 UNI EN 1090:2014</p>

I punti di forza di Kedry Skylife

KE

Kedry Skylife 9

KEDRY SKYLIFE AWNINGS' BENEFITS
VENTAJAS DE LOS TOLDOS PARA KEDRY SKYLIFE
LES POINTS FORTS DE KEDRY SKYLIFE



IT IMPACCHETTAMENTO
sistema di lame con chiusura ad impacchettamento. Le lame in apertura e chiusura ruotano in un unico movimento.
Dimensioni massime per singolo modulo
L.450 P.611 cm

EN RETRACTABLE
Folding and retractable blades system. The opening and closing blades rotate in a single movement. Maximum dimensions for single module
W 450 P 611 cm .

FR EMPAQUETEMENT
Système de lames rétractables par empaquètement. Les lames s'orientent et se rétractent dans un unique mouvement à l'ouverture et à la fermeture. Les dimensions réalisables pour un module simple sont de L 450 x A 611 cm

ES EMPAQUETAMIENTO
Sistema de lamas con cierre por empaquetamiento. Las lamas en apertura y cierre rotan en un único movimiento. Medidas máximas para el módulo sencillo L450 S611 cm.

IT INGOMBRO LAME COMPATTATE:
N° 28 lame - massimo ingombro 106 cm.

EN COMPACTED BLADES DIMENSIONS:
28 blades - maximum overall dimensions 106 cm.

FR ENCOMBREMENT LAMES RÉTRACTÉES:
28 lames - encombrement maximal de 106cm.

ES MEDIDAS LAMAS EMPAQUETADAS
N° 28 lamas: máxima medida 106 cm.

IT MODULARITÀ
moduli affiancabili senza limitazione di misure in larghezza e sporgenza.

EN MODULAR SYSTEM
infinite number of modules can be installed side by side.

FR MODULARITÉ modules
additionnables sans limites de mesures en largeur comme en avancée.

ES MODULARIDAD
módulos encajables, sin límites para modificar su longitud de anchura y del saliente.

IT ILLUMINAZIONE
con strip led esterno (rgb) ed interno bianco.

EN ILLUMINATION
with LED strips external (rgb) and internal, blades.

FR ECLAIRAGE
avec bandeaux LED Interne et externe.

ES ILUMINACIÓN
con tiras LED interna y exterior, lamas.

IT CHIUSURE
Possibilità di chiusura con tende tecniche verticali integrate, sistemi di vetrate scorrevoli e tende a drappo.

EN CLOSURE
Possibility of side closures with vertical drop down screens, sliding glass doors and draped curtains.

FR FERMETURE
Possibilité de fermetures latérales avec stores verticaux, vitrage coulissant et/ou rideaux drapés.

ES CIERRE
Posibilidad de cierre perimetral con toldos verticales, corredera de cristal y rideaux drapés.

IT PIOGGIA E CARICO VENTO
Un sistema di raccolta acqua, grondaie perimetrali e pluviali, fa defluire l'acqua attraverso le colonne. Elevate performance di resistenza al vento, testate e certificate.

EN A gutter system allows draining of water through the columns. The louver blades have been designed to allow water draining along a built-in gutter, which work even when opening them. Wind resistance and the load.

FR Un système de récupération de l'eau avec gouttières pluviales permet d'écouler l'eau à travers les colonnes. Les lames sont conçues pour permettre son évacuation sur un périmètre choisi de la pergola à l'aide d'un bac de récupération intégré.

ES Un sistema de recogida de agua, cañerías pluviales, hace fluir el agua atravesando las columnas. Resistencia al viento y carga.

KEDRY SKYLIFE	Bioclimatica
----------------------	--------------





IT Bioclimatica in alluminio, con tetto a lame orientabili ed impacchettabili, studiata per garantire massima tenuta alle intemperie. Movimentazione garantita da sistemi motorizzati robusti e affidabili. Stilisticamente pulita, per la sua configurazione modulare si presta a coprire qualsiasi tipo di dehor, patio o terrazzo. Chiudibile perimetralmente con tende a zip, vetrate panoramiche e tende a drappo.

EN Aluminum framework with swiveling louver blades, designed to ensure optimal resistance against the elements. Moved by robust and powerful systems motors. Being modular and having a clean design, it fits any kind of patio, terrace and outdoor space. It can be closed all around through either side awnings with zippers or windows

FR Structure en aluminium, avec toit à lames orientables, étudiée pour assurer une résistance maximale face aux intempéries. Mouvement garanti par des systèmes motorisés robustes et fiables. Au style épuré, grâce à sa configuration modulaire, il est possible de couvrir tous types d'extérieur, patio ou terrasse. Se ferme latéralement à l'aide de stores verticaux zippés ou vitrage coulissant.

ES Structure en aluminium, avec un toit avec des lames orientables, étudiée pour assurer une étanchéité maximale face aux intempéries. Déplacement assuré grâce à des systèmes de moteur robustes et puissants. De style épuré, avec sa configuration modulaire, on peut couvrir tout type d'extérieur, patio ou terrasse. Se ferme périmétriquement à l'aide de tentes avec des fermetures éclair ou vitrage.



				
Resistenza al sole Sun resistance Résistance au soleil Resistencia al sol	Resistenza al vento, classe 6 Wind resistance, grade 6 Résistance au vent, classe 6 Resistencia al viento, grado 6	Massima larghezza: mod. singolo 450 cm Maximum width: single module 450 cm Largeur maximale: module simple 450 cm Ancho máximo: módulo único 450 cm	Massima sporgenza: mod. singolo 611 cm Maximum projection: single module 611 cm Avancée maximale: module simple 611 cm Protuberancia máxima: módulo único 611 cm	Testato e certificato CE e TUV Tested and certified CE and TUV Testé et certifié CE et TUV Probado y certificado CE y TUV

			OPTIONAL
Illuminazione Light Lumière Iluminación	Tenda a rullo Vertika Vertika roller awnings Stores verticaux Vertika Vertika cortinas enrollables	Vetrate panoramiche Line Glass Line Glass panoramic glass Vitrage panoramique Line Glass Acristalamiento panorámico Line Glass	

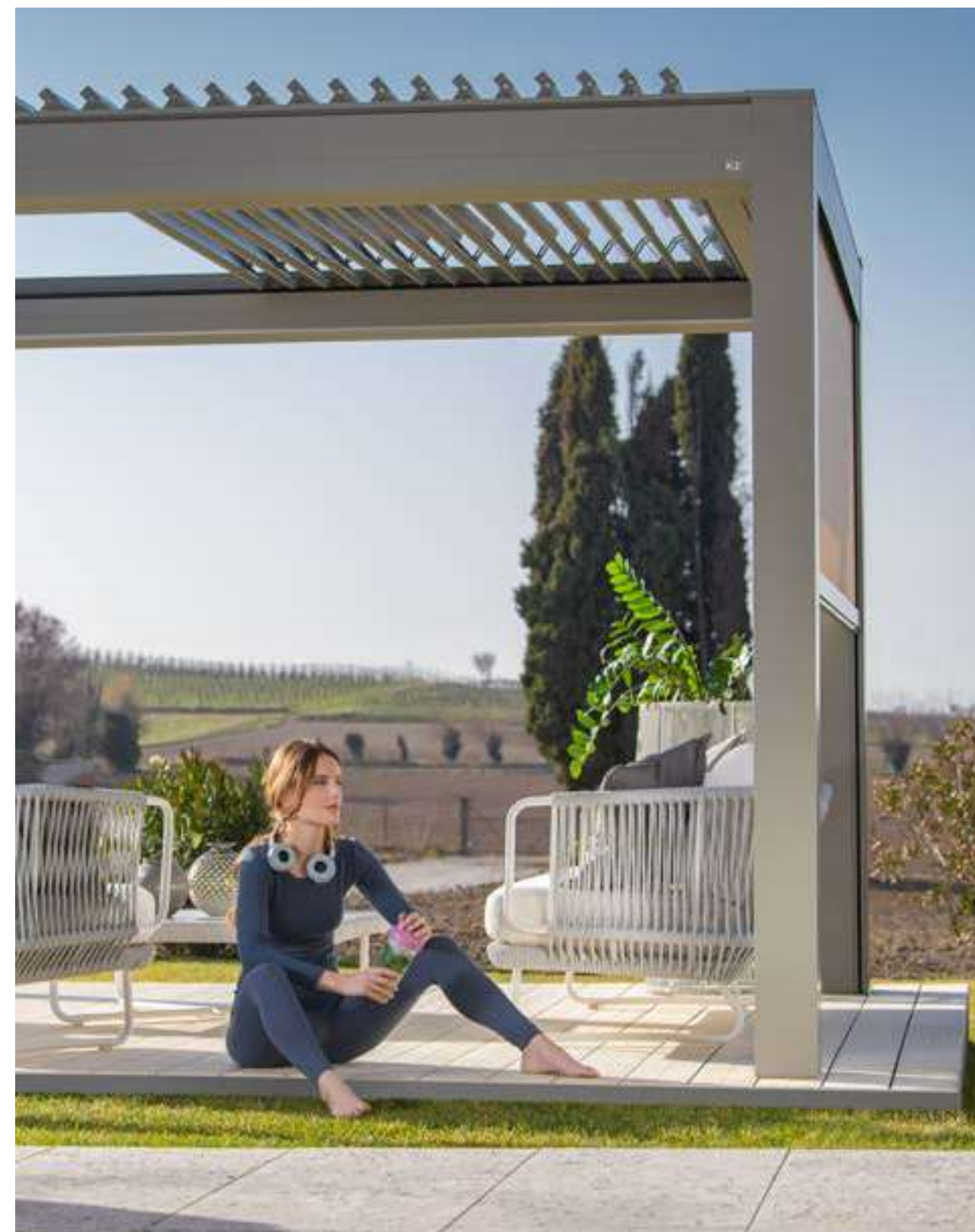







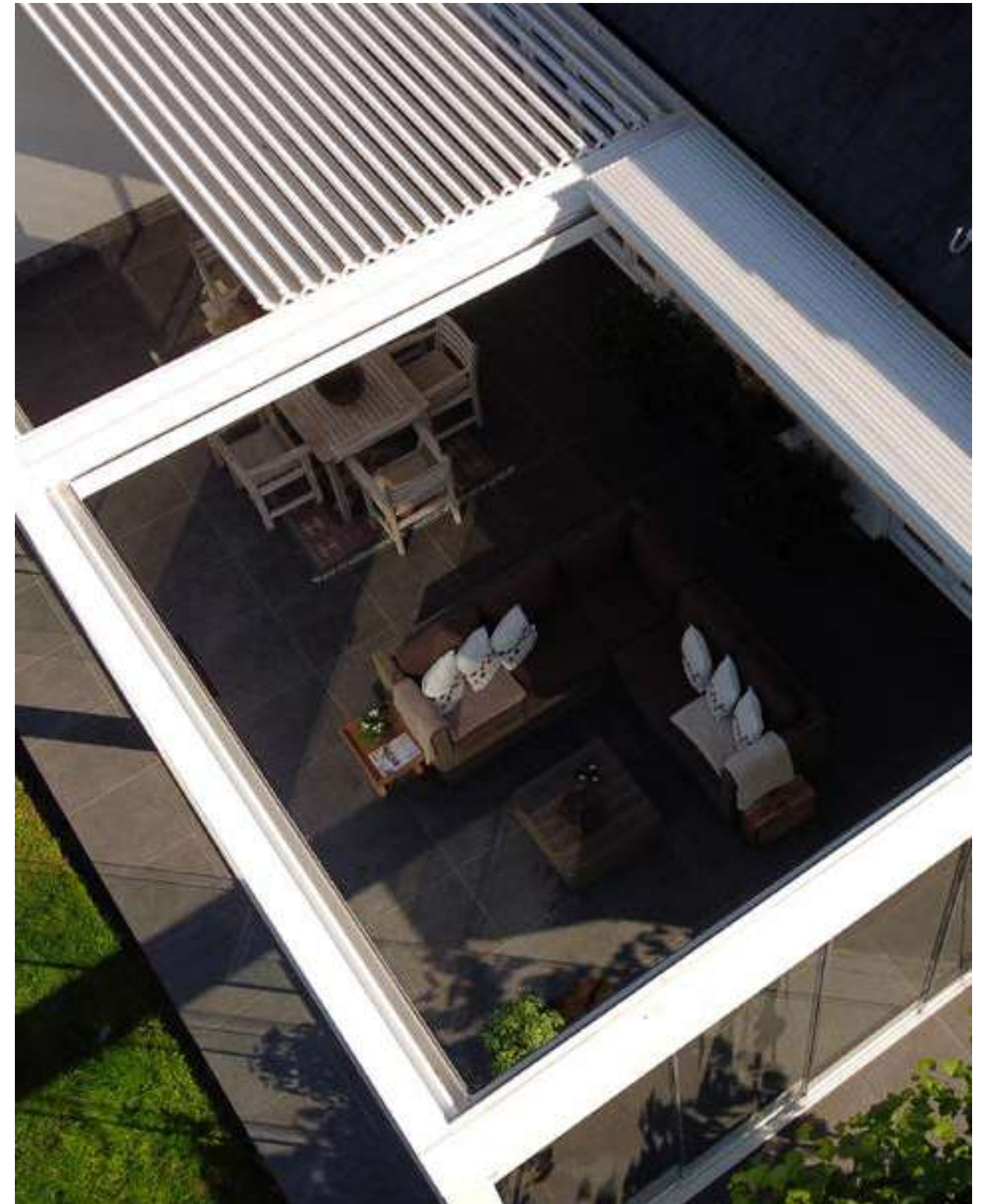



I punti di forza di Kedry Prime

KEDRY PRIME AWNINGS' BENEFITS
VENTAJAS DE LOS TOLDOS PARA KEDRY PRIME
LES POINTS FORTS DE KEDRY PRIME



IT MODULARITÀ
moduli affiancabili senza limitazione di misure in larghezza e sporgenza.

EN MODULAR SYSTEM
infinite number of modules can be installed side by side.

FR MODULARITÉ
modules additionnables, sans limitation pour atteindre de plus grandes dimensions en largeur comme en avancée.

ES MODULARIDAD
módulos encajables, sin límites para modificar su longitud de anchura y del saliente.

IT ILLUMINAZIONE
con strip led esterno (rgb) ed interno bianco.

EN ILLUMINATION
with LED strips external (rgb), internal, blades.

FR ECLAIRAGE
avec bandeaux LED Interne, externe, lames.

ES ILUMINACIÓN
con tiras LED interna, exterior, lamas.

IT CHIUSURE
Possibilità di chiusura con tende tecniche verticali, sistemi di vetrate scorrevoli e tende a drappo .

EN CLOSURE
Possibility of side closures with vertical drop down screens, sliding glass doors and draped curtains.

FR FERMETURE
Possibilité de fermetures latérales avec stores verticaux, vitrage coulissant et/ou rideaux drapés.

ES CIERRE
Posibilidad de cierre perimetral con toldos verticales, corredera de cristal y rideaux drapés.

IT Un sistema di raccolta acqua, grondaie perimetrali e pluviali, fa defluire l'acqua attraverso le colonne. Le lame sono state progettate per permettere l'evacuazione dell'acqua attraverso un gocciolatoio integrato.

EN A gutter system allows draining of water through the columns. the louver blades have been designed to allow water draining along a built-in gutter, which work even when opening them.

FR Un système de récupération de l'eau avec gouttières pluviales permet d'écouler l'eau à travers les colonnes. Les lames sont conçues pour permettre son évacuation sur un périmètre choisi de la pergola à l'aide d'un bac de récupération intégré.

ES A gutter system allows draining of water through the columns. the louver blades have been designed to allow water draining along a built-in gutter, which work even when opening them.

IT ORIENTAMENTO
Rotazione delle lame fino a 135°.

EN ORIENTATION
rotation of blades until 135°.

FR ORIENTATION
rotation des lames jusqu'à 135 °.

ES ORIENTATION
rotation des lames jusqu'à 135° .

IT Resistenza al carico vento
elevate performance, testate e certificate.

EN Wind resistance and the load.

FR Résistance au vent et à la charge.

ES Resistencia al viento y carga.

KEDRY PRIME









Bioclimatica

IT Un prodotto adatto ad ogni stagione, per creare nuovi spazi outdoor, vivibili e funzionali. Elegante e personalizzabile. L'illuminazione integrata nei profili e nelle lame e la possibilità di chiusure perimetrali permettono di vivere lo spazio esterno anche di notte.

EN A functional product for every season, to create new outdoor spaces, extremely liveable and functional. Elegant and customisable. The lighting integrated in the profiles and blades and the option for perimeter closures make the outdoor spaces liveable at night as well.

FR Un produit adapté à chaque saison, qui permet de créer de nouveaux espaces extérieurs confortables et fonctionnels. Élégant et personnalisable. L'éclairage intégré dans les profils et dans les lames ainsi que la possibilité de fermetures latérales permettent de prolonger l'utilisation de l'espace extérieur même la nuit.

ES Un producto funcional durante todo el año que permite crear nuevos espacios habitables y utilitarios al aire libre. Elegante y personalizable. La iluminación integrada en los perímetros y en las lamas, y la posibilidad de cierre perimetral permiten disfrutar del espacio exterior también de noche.

				
Resistenza al sole Sun resistance Résistance au soleil Resistencia al sol	Resistenza al vento, classe 6 Wind resistance, grade 6 Résistance au vent, classe 6 Resistencia al viento, grado 6	Massima larghezza: mod. singolo 500 cm Maximum width: single module 500 cm Largeur maximale: module simple 500 cm Ancho máximo: módulo único 500 cm	Massima sporgenza: mod. singolo 705 cm Maximum projection: single module 705 cm Avancée maximale: module simple 705 cm Protuberancia máxima: módulo único 705 cm	Testato e certificato CE e TUV Tested and certified CE and TUV Testé et certifié CE et TUV Probado y certificado CE y TUV
			OPTIONAL	
illuminazione Light Lumière Iluminación	Tenda a rullo Vertika Vertika roller awnings Stores verticaux Vertika Vertika cortinas enrollables	Vetrare panoramiche Line Glass Line Glass panoramic glass Vitrage panoramique Line Glass Acristalamiento panorámico Line Glass		







IT Lame orientabili per modulare la luce, proteggere dalla pioggia e assicurare un perfetto microclima al di sotto della copertura. I led integrati nella struttura garantiscono un'illuminazione a luce indiretta.

EN Swiveling louver blades that allow light adjustment and protection from the rain, and ensure a perfect microclimate under the roof. The integrated LED spotlights ensure an illumination with reflected light.

FR Lames orientables pour réguler l'apport en lumière, se protéger de la pluie et assurer un microclimat parfait sous la pergola. L'éclairage LED intégré permet une utilisation prolongée de la pergola.

ES Lamelas orientables para graduar la luz, proteger de la lluvia y asegurar un microclima perfecto bajo la cobertura. El iluminado LED integrado permite una iluminación con luz indirecta.

IT Kedry Prime ha una modularità che permette di affiancare più strutture senza raddoppiare il pilastro centrale mantenendo un design inconfondibile. Può essere dotata di chiusure perimetrali: vetrate panoramiche, tende a rullo integrate e tende a drappo.

EN Kedry Prime's modularity allows the combination of multiple structures without having to double the central upright, keeping its unmistakable design. It can be fitted with perimeter closures: glass panels, Vertika and drape

FR Kedry Prime, grâce à sa modularité peut-être composé de plusieurs modules reposant sur des poteaux communs et maintenant un design inimitable. Il peut être équipé de fermetures latérales : Line glass, Vertika et rideaux drapés.

ES Kedry Prime presenta un sistema modular que permite unir más estructuras sin duplicar el pilar central, conservando de ese modo un diseño inconfundible. Se puede dotar de cierres perimetrales: ventanales, Vertika y cortinas.



I punti di forza di Kedry Plus

KEDRY PLUS AWNINGS' BENEFITS
 VENTAJAS DE LOS TOLDOS PARA KEDRY PLUS
 LES POINTS FORTS DE KEDRY PLUS



IT MISURE MAX
 copertura fino a 4 metri di larghezza, sporgenza 8 metri.

EN MAX DIMENSIONS
 up to 4 meters can be covered, with 8-meter projection.

FR MESURES MAX couvrir jusqu'à 4 mètres de large, avancée 8 mètres.

ES MEDIDA MÁXIMA
 cubierta de hasta 4 metros de anchura, saliente 8 metros.

IT PROTEZIONE
 dai raggi solari attraverso la rotazione delle lame.

EN SCREENING SUN RAYS
 through the swiveling louver blades.

FR PROTECTION du rayonnement solaire grâce à la rotation des lames.

ES PROTECCIÓN SOLAR
 mediante la rotación de las láminas.

IT FLESSIBILITÀ DI INSTALLAZIONE
 con fissaggio a parete, in autoportanza o come copertura su strutture preesistenti.

EN FLEXIBLE INSTALLATION
 both wall-mount and free-standing installations are possible, and they can even serve as a roof for existing frameworks.

FR FLEXIBILITE D'INSTALLATION
 adossée, autoportant, ou sur des structures existantes.

ES INSTALACIÓN FLEXIBLE
 con fijación a la pared, autoportante o como marquesinas sobre estructuras ya existent.



IT ILLUMINAZIONE
 con strip led esterno (rgb) ed interno bianco.

EN ILLUMINATION
 with LED strips external (rgb), internal, blades.

FR ECLAIRAGE
 avec bandeaux LED Interne, externe, lames.

ES ILUMINACIÓN
 con tiras LED interna, exterior, lamas.



IT RESISTENZA AI CARICHI VENTO
 elevate performance, testate e certificate.

EN WIND RESISTANCE
 and the load.

FR RÉSISTANCE AU VENT
 et à la charge.

ES RESISTENCIA AL VIENTO
 y carga.



IT PIOGGIA
 Un sistema di raccolta acqua, grondaie perimetrali e pluviali, fa defluire l'acqua attraverso le colonne. Le lame sono state progettate per permettere l'evacuazione dell'acqua attraverso un gocciolatoio integrato.

EN RAIN
 A gutter system allows draining of water through the columns. the louver blades have been designed to allow water draining along a built-in gutter.

FR PLUIE
 Un système de récupération de l'eau avec gouttières pluviales permet d'écouler l'eau à travers les colonnes. Les lames sont conçues pour permettre son évacuation sur un périmètre choisi de la pergola à l'aide d'un bac de récupération intégré.

ES LLUVIA
 Un sistema de recogida de agua, cañerías pluviales, hace fluir el agua atravesando las columnas. Las láminas han sido proyectadas para permitir la evacuación del agua mediante una cañería integrada.

KEDRY PLUS





Bioclimatica

IT Le bioclimatiche Kedry Plus rappresentano una soluzione versatile anche per quanto riguarda l'installazione. Oltre alla versione addossata e autoportante si propone la versione tetto priva di pilastri e da installare su struttura appositamente predisposta. In questo modo la medesima qualità e funzionalità di Kedry Plus sono inseribili in ogni contesto architettonico.

EN Kedry Plus are a versatile solution also as far as installation is concerned. Two versions are available: one with wall-mount and support pillars and the other in roof style without pillars. Hence Kedry's typical quality and functionality can be applied to any architectural context.

FR Les pergolas Kedry Plus représentent une solution polyvalente également en termes d'installation. En plus de la version adossée et autoportante, il existe également une version de toit sans poteaux, à installer sur une structure déjà existante. De cette façon, la même qualité et fonctionnalité de Kedry Plus peut être insérée dans n'importe quel contexte architectural.

ES Los sistemas Kedry Plus representan una solución versátil para la instalación. Están disponibles tanto la versión con anclaje a la pared y pilares de soporte como la versión de techo, desprovista de pilares. De este modo la misma calidad y funcionalidad que nos ofrece Kedry se pueden utilizar en diferentes contextos arquitectónicos.

				
Resistenza al sole Sun resistance Résistance au soleil Resistencia al sol	Resistenza al vento, classe 6 Wind resistance, grade 6 Résistance au vent, classe 6 Resistencia al viento, grado 6	Massima larghezza: mod. singolo 400 cm Maximum width: single module 400 cm Largeur maximale: module simple 400 cm Ancho máximo: módulo único 400 cm	Massima sporgenza: mod. singolo 810 cm Maximum projection: single module 810 cm Avancée maximale: module simple 810 cm Protuberancia máxima: módulo único 810 cm	Testato e certificato CE e TUV Tested and certified CE and TUV Testé et certifié CE et TUV Probado y certificado CE y TUV

			OPTIONAL
illuminazione Light Lumière Iluminación	Tenda a rullo Vertika Vertika roller awnings Stores verticaux Vertika Vertika cortinas enrollables	Vetrare panoramiche Line Glass Line Glass panoramic glass Vitrage panoramique Line Glass Acristalamiento panorámico Line Glass	







LINE GLASS 10-12

IT Le vetrate scorrevoli panoramiche permettono di chiudere perimetralmente le pergole bioclimatiche, sono ancorate a terra su guide in alluminio ad altezza ridotta (solo 18 mm) e scorrono sia a destra che a sinistra. Le ante in chiusura si sovrappongono parzialmente e sono provviste di guarnizione per proteggere dagli agenti atmosferici.

EN Sliding windows allow perimeter closure of the bioclimatic pergola, they are anchored to the floor on metal guides of minimal height (merely 18 mm) and slide both to the right or to the left. Wings are vertically overlapping and are fitted with a sealer trimming to protect them from wind and rain.

FR Les vitrages coulissants permettent de fermer latéralement la structure et reposent au sol sur des rails en métal de hauteur réduite (seulement 18 mm). Ils se coulissent vers la gauche et vers la droite. Les vantaux de verre se superposent pour un encombrement minimal une fois ouvert. Un système de joints assure une protection contre la pluie et le vent.

ES Los ventanales correderos permiten cerrar las estructuras perimetralmente. Se fijan al suelo sobre guías de metal de altura reducida (solo 18 mm) y se deslizan tanto hacia la derecha como hacia la izquierda. Las hojas se superponen verticalmente y están dotadas de juntas para proteger de la lluvia y del viento.



VERTIKA

IT Vertika è una chiusura verticale che permette di proteggere dal sole e dagli agenti atmosferici. Con Vertika si possono utilizzare tessuti oscuranti e filtranti per poter gestire al meglio l'irraggiamento solare.

EN Vertically closing Vertika protects from sun and atmospheric agents. With Vertika, blanking and filtering fabrics can be used to manage light at best.

FR Ver tika est une fermeture verticale qui permet de protéger du soleil et des agents atmosphériques. Avec Vertika il est possible d'utiliser des tissus occultants et filtrants afin de gérer l'apport en lumière.

ES Vertika es un sistema de cierre vertical que permite proteger del sol y de otros agentes atmosféricos. Con Vertika se pueden utilizar tejidos opacos y semiopacos para poder gestionar la entrada de luz de la mejor manera



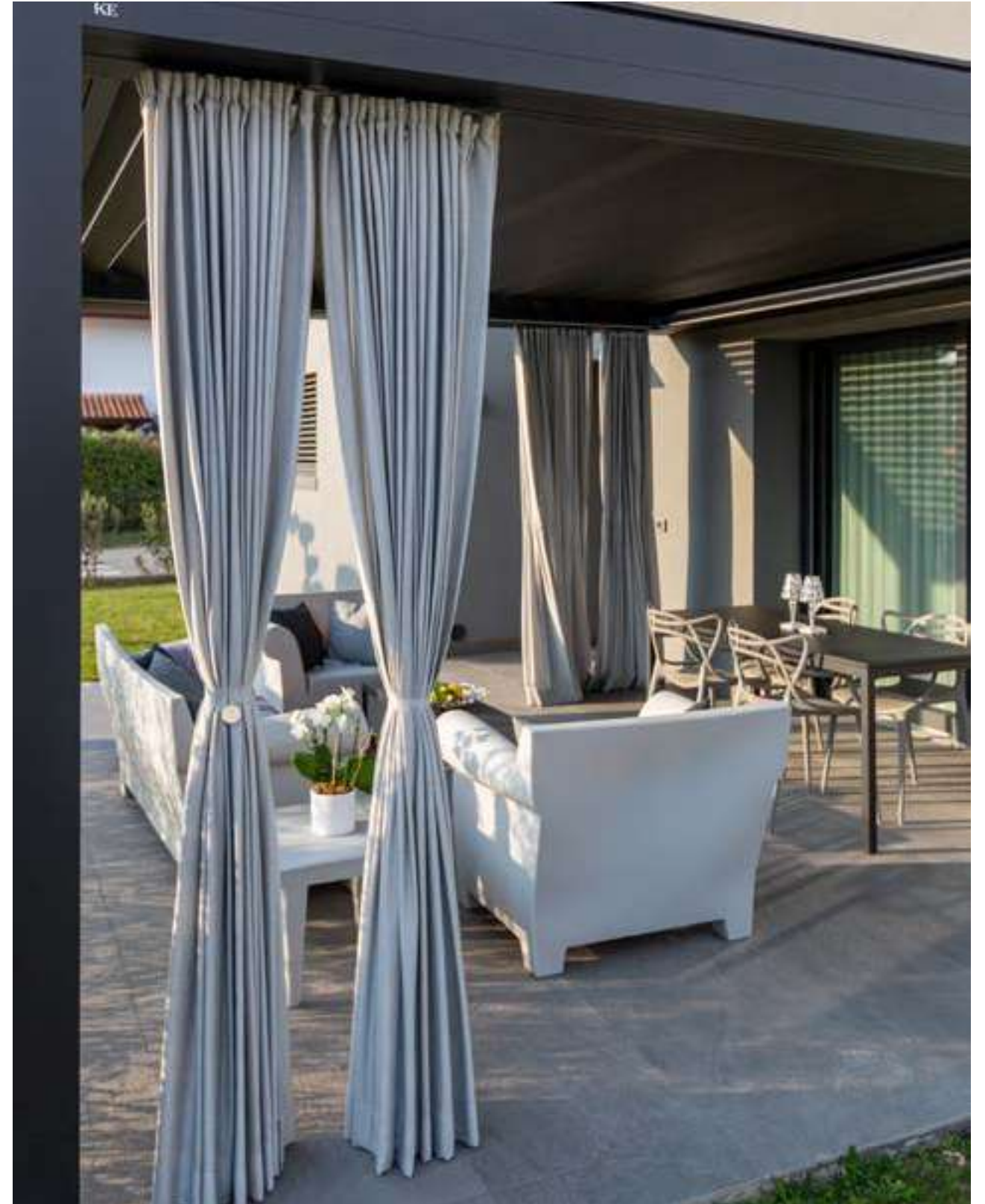

Accessori e finiture

KE

Bioclimatica 47

ACCESSORIES AND FINISHES
ACCESSOIRES ET FINITIONS
ACCESORIOS Y ACABADOS



IT AUTOMAZIONE
sensori climatici (vento, pioggia, sole) combinati ad automazione di ultima generazione, permettono la creazione di scenari personalizzati, che definiscono tempo e modalità di apertura e chiusura della tenda. Le app per smartphone e tablet ne consentono un costante controllo da remoto.

EN AUTOMATION
wind, rain and sun sensors, together with cutting-edge automation, allow to customize the awning use, defining when and how it should open or close. The apps for smartphones and tablets allow to remotely control the awnings in every moment

FR AUTOMATISATION
capteurs météorologiques (vent, pluie, soleil) combinés avec l'automatisation de dernière génération. Cela permet la création de scénarios personnalisés, qui définissent l'heure et la méthode d'ouverture et de fermeture du store. Applications pour smartphones et tablettes permettent un contrôle constant à distance.

ES AUTOMATISATION
capteurs meteorológicos (vent, lluvia, sol) combinados con la automatización de última generación, permiten la creación de escenarios personalizados, que definen el tiempo y el método de apertura y de cierre de la tienda. Aplicaciones para smartphones y tabletas permiten un control constante a distancia



IT SENZA FILI
Gestisci i dispositivi connessi tramite APP sul tuo smartphone, ovunque tu sia.

EN WIRELESS
Manage connected devices via APP on your smartphone, wherever you are.

FR WIRELESS
Gérez les appareils connectés via l'APP sur votre smartphone, où que vous soyez.

ES WIRELESS
Gestiona los dispositivos conectados a través de la APP de tu smartphone, estés donde estés.

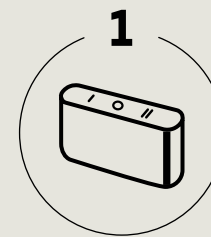

IT Con il controllo smart Avvia i tuoi scenari con un solo click.
EN With smart control Start your scenarios with a single click.
FR Avec un contrôle intelligent Démarrez vos scénarios d'un simple clic.
ES Con control inteligente Inicia tus escenarios con un solo clic.

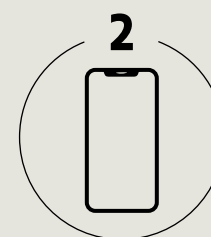

IT Programma e gestisci i suoi dispositivi da casa, a distanza o automaticamente.
EN Program and manage its devices from home, remotely or automatically.
FR Programmer et gérer ses appareils depuis chez soi, à distance ou automatiquement.
ES Programe y gestione sus dispositivos desde casa, a distancia o automáticamente.

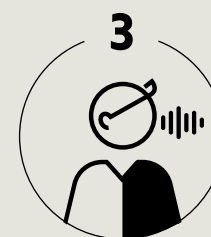

IT Con uno smart speaker quando hai le mani occupate o stai guidando.
EN With a smart speaker when your hands are full or you are driving.
FR Avec un haut-parleur intelligent lorsque vos mains sont occupées ou que vous conduisez.
ES Con un altavoz inteligente cuando tienes las manos ocupadas o estás conduciendo.

Accessori e finiture

KE

Bioclimatica 49

ACCESSORIES AND FINISHES
ACCESSOIRES ET FINITIONS
ACCESORIOS Y ACABADOS

IT METALLI

le strutture metalliche sono costituite da profili ed accessori in alluminio termolaccato o acciaio (viterie inox). La resistenza alla corrosione è ottenuta grazie a innovativi processi di trattamento di superficie che permettono di classificare i componenti esterni in classe 4 secondo EN 13561:2015.

EN METALS

the metal frames are composed of profiles and accessories made of steel or thermo-varnished aluminum (stainless steel hardware). Resistance to corrosion is ensured by innovative surface treatments that allow external components to rank in class EN 13561:2015.

FR METAUX

Les structures métalliques sont constituées de profils et d'accessoires en aluminium thermo laqués ou en acier (vis inox). La résistance à la corrosion est obtenue grâce à des procédés innovants de traitement des surfaces qui permettent de classer les composants extérieurs en class EN 13561:2015.

ES METALES

las estructuras metálicas están formadas por perfiles y accesorios de aluminio termolacado o acero (tornillos inox). La resistencia a la corrosión se ha conseguido gracias a innovadores procesos de tratamiento de superficies que permiten clasificar los componentes externos en class EN 13561:2015.



IT TESSUTI

confort termico e perfetta integrazione estetica grazie ad un'ampia gamma di tessuti tecnici (oltre 500) che permettono la regolazione del fattore solare in base alle specifiche esigenze dell'edificio, assicurando la massima coerenza stilistica. Tutti i tessuti sono certificati secondo la norma tecnica per la marcatura CE del prodotto EN 13561 ed EN 14501

EN FABRICS

thermal comfort and perfect aesthetic integration are guaranteed by a wide range of technical fabrics (over 500), which allow to adjust the solar factor according to the specific needs of the building, keeping the maximum consistency of style. All fabrics are certified in compliance to the technical regulations for CE marking: EN 13561 and EN 14501

FR TISSUS

confort thermique et intégration esthétique parfaite avec une large gamme de tissus techniques (500) qui permettent l'ajustement du facteur solaire en fonction des besoins spécifiques du lieu tout en assurant une cohérence de style maximum. Tous les tissus sont certifiés selon la norme technique pour le marquage du produit EN 13561 et EN 14501

ES TEJIDOS

confort térmico y perfecta integración estética gracias a una amplia gama de tejidos técnicos (más de 500) que permiten la regulación de factores solares en base a las exigencias específicas del edificio, asegurando la máxima coherencia estilística. Todos los tejidos están certificados según la normativa técnica por la etiqueta CE del producto EN 13561 y EN 14501

IT ESCLUSIVA KE - IRISUN BLOCKOUT

Il tessuto Irisun Blockout è l'equilibrio perfetto tra design, protezione dal sole e comfort termico. Irisun Blockout è l'innovativo tessuto con il lato esterno in acrilico e quello interno in poliestere dall'aspetto luminoso e leggero

EN KE EXCLUSIVE - IRISUN BLOCKOUT fabric

Irisun Blockout fabric is the perfect balance between design, sun protection and thermal comfort. Irisun Blockout is the innovative fabric with the outer side in acrylic and the inner side in polyester, with a bright and light look.

FR EXCLUSIF KE - IRISUN BLOCKOUT

Le tissu Irisun Blockout est l'équilibre parfait entre le design, la protection solaire et le confort thermique. Irisun Blockout est un tissu innovant dont la face extérieure est en acrylique et la face intérieure en polyester d'aspect lumineux et léger.

ES KE EXCLUSIVO - IRISUN BLOCKOUT

El tejido Irisun Blockout es el equilibrio perfecto entre diseño, protección solar y confort térmico. Irisun Blockout es el innovador tejido con la cara exterior en acrílico y la cara interior en poliéster brillante y ligero.



WATER
REPELLENT



BLOCKOUT

FINISHES
FINITIONS
ACABADOS







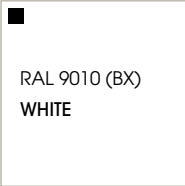
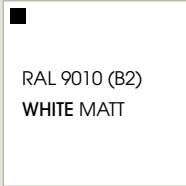
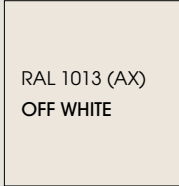
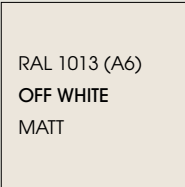

IT Quando si affronta il colore lo si fa con la consapevolezza che tutto il nostro mondo è disegnato dalla luce. E il colore altro non è che una scomposizione della luce. La materia che osserviamo assorbe tutti i colori dell'iride, rimandando allo sguardo soltanto il colore che la definisce. Ecco perché è così importante riconoscere lo stretto legame che c'è tra colore e materia. Per questo progetto, tre sono le parole chiave che guidano la ricerca: Parole, Luoghi, Materie.

EN When we see color, we do it with the awareness that our whole world is created by light. Color is nothing more than components of light. The object we observe absorbs all light except what it reflects back to our eyes, only the color that defines it. This is why it is so important to recognize the close link that exists between color and matter. For this project, there are three keywords that guide the research: Words, Places, Matters.

FR Lorsque nous faisons face à la couleur, nous le faisons avec la conscience que notre monde entier est conçu par la lumière. Et la couleur n'est rien de plus qu'un composant de la lumière. Le matériau que nous observons absorbe toutes les couleurs de l'iris, se référant à l'oeil uniquement la couleur qui le définit. C'est pourquoi il est si important de reconnaître le lien étroit qui existe entre la couleur et la matière. Pour ce projet, trois mots-clés guident la recherche : Mots, Lieux, Matériaux.

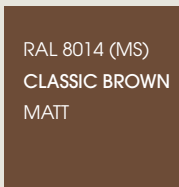
ES Cuando nos enfrentamos al color lo hacemos con la conciencia de que todo nuestro mundo está diseñado por la luz. Y el color no es más que una descomposición de la luz. El material que observamos absorbe todos los colores del iris, refiriéndose únicamente al color que lo define. Por eso es tan importante reconocer el estrecho vínculo que existe entre el color y la materia. Para este proyecto, hay tres palabras clave que guían la investigación: Palabras, Lugares, Materias

Essential

 <p>RAL 9010 (BX) WHITE</p>	 <p>RAL 9010 (B2) WHITE MATT</p>	 <p>RAL 1013 (AX) OFF WHITE</p>
 <p>RAL 1013 (A6) OFF WHITE MATT</p>	 <p>RAL 9006 (G6) ALUMINIUM</p>	 <p>RAL 9006 (6O) ALUMINIUM MATT</p>
 <p>RAL 9007 (GL) DARK ALU.</p>	 <p>RAL 9007 (Z4) DARK ALU. MATT</p>	 <p>RAL 8014 (MS) CLASSIC BROWN MATT</p>
 <p>CORTEN (MR) ROUGH</p>	 <p>RAL 7016 (Z6) IRON MATT</p>	 <p>CARBON (NV) ROUGH</p>

■ Standard

Sensitive

 <p>RAL 9003 (NJ) COTTON MATT</p>	 <p>RAL 9002 (HL) WHITE GREY MATT</p>	 <p>RAL 7038 (XG) RESIN MATT</p>	 <p>RAL 7044 (TT) NATURAL STONE MATT</p>	 <p>RAL 7042 (7G) GREY STONE MATT</p>	 <p>RAL 7030 (ZB) WARM GRAY MATT</p>
 <p>RAL 1019 (A4) WASHED WOOD MATT</p>	 <p>RAL 1015 (A7) SAND MATT</p>	 <p>RAL 7006 (ZA) DUST MATT</p>	 <p>RAL 8017 (MW) GROUND MATT</p>	 <p>RAL 3007 (R6) BLACK RED MATT</p>	 <p>RAL 8019 (MK) NIGHT BROWN MATT</p>
 <p>RAL 7021 (T4) OFF BLACK MATT</p>	 <p>RAL 6007 (W2) MIMETIC MATT</p>	 <p>RAL 6025 (VQ) LEAF MATT</p>	 <p>RAL 6003 (W1) FOREST MATT</p>	 <p>RAL 5000 (FJ) MOONLIGHT MATT</p>	 <p>NCS S1515- R80B (F3) SKY ROUGH</p>
 <p>NCS 1050- B30G (F6) POOL MATT</p>	 <p>RAL 5002 (FT) PRIME B MATT</p>	 <p>RAL 1023 (C7) PRIME Y MATT</p>	 <p>RAL 3002 (R2) PRIME R MATT</p>		

KE



Visita il nostro sito/ Visit our website
www.keoutdoordesign.com

cod. D_GENNIUS_23